

Overview



Transmitter MAG 5000/6000 compact version (left) and 19" insert version (right)

The MAG 5000 and 6000 are transmitters engineered for high performance, easy installation, commissioning and maintenance. The transmitters evaluate the signals from the SITRANS F M sensors type MAG 1100, MAG 1100 F, MAG 3100, MAG 3100 P and MAG 5100 W.

Transmitter types:

- MAG 5000: Max. measuring error $\pm 0.4 \% \pm 1 \text{ mm/s}$ (incl. sensor)
- MAG 6000: Max. measuring error $\pm 0.2 \% \pm 1 \text{ mm/s}$ (incl. sensor, see also sensor specifications) and with additional features such as: "plug & play" add-on bus modules; integrated batch functions.

Benefits

- Superior signal resolution for optimum turn down ratio
- Digital signal processing with many possibilities
- Automatic reading of SENSORPROM data for easy commissioning
- User configurable operation menu with password protection.
- 3 lines, 20 characters display in 11 languages.
- Flow rate in various units
- Totalizer for forward, reverse and net flow as well as additional information available
- Multiple functional outputs for process control, minimum configuration with analogue, pulse/frequency and relay output (status, flow direction, limits)
- Comprehensive self-diagnostic for error indication and error logging (see under SITRANS F M diagnostics)
- Batch control (MAG 6000 only)
- Custody transfer approval: PTB, OIML R 117, OIML R 49, MI-001, PTB K 7.2 and OE12/C 040 for chilled water
- MAG 6000 with add-on bus modules for HART, FOUNDATION Fieldbus H1, DeviceNet, Modbus RTU/RS 485, PROFIBUS PA and DP

Application

The SITRANS F M flowmeters are suitable for measuring the flow of almost all electrically conductive liquids, pastes and slurries. The main applications can be found in:

- Water and waste water
- Chemical and pharmaceutical industries
- Food and beverage industries
- Power generation and utility

Design

The transmitter is designed as either IP67 NEMA 4X/6 enclosure for compact or wall mounting or 19" version as a 19" insert as a base to be used in:

- 19" rack systems
- Panel mounting IP20/NEMA 1 (prepared for IP65/NEMA 2 display side)
- Back of panel mounting IP20/NEMA 1
- Wall mounting IP66/NEMA 4X

Several options on 19" versions are available such as:

- Transmitters mounted in safe area for Ex ATEX approved flow sensors (incl. barriers)
- Transmitters with electrode cleaning unit on request

Function

The MAG 5000/6000 are transmitters with a built-in alphanumeric display in several languages. The transmitters evaluate the signals from the associated electromagnetic sensors and also fulfil the task of a power supply unit which provides the magnet coils with a constant current.

Further information on connection, mode of operation and installation can be found in the data sheets for the sensors.

Displays and controls

Operation of the transmitter can be carried out using:

- Control and display unit
- HART communicator
- PC/laptop and SIMATIC PDM software via HART communication
- PC/laptop and SIMATIC PDM software using PROFIBUS or Modbus communication

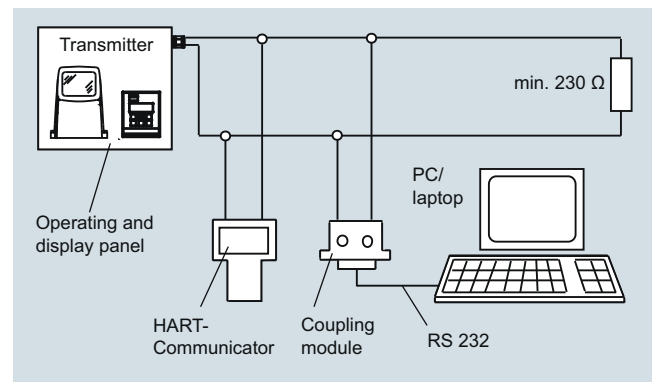

HART communication

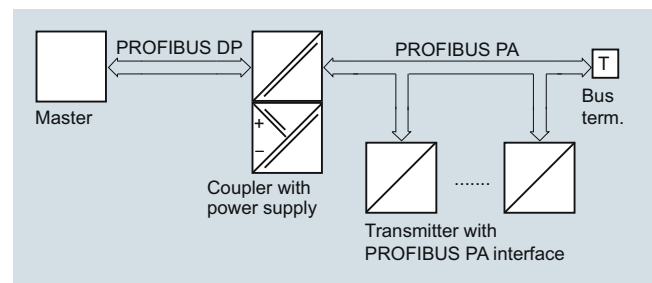

PROFIBUS PA communication

Flow Measurement

SITRANS F M

Transmitter MAG 5000/6000

Technical specifications

Mode of operation and design

Measuring principle	Electromagnetic with pulsed constant field
Empty pipe	Detection of empty pipe (special cable required in remote mounted installation)
Excitation frequency	Depend on sensor size
Electrode input impedance	$> 1 \times 10^{14} \Omega$

Input

Digital input	11 ... 30 V DC, $R_i = 4.4 \text{ K}\Omega$
• Activation time	50 ms
• Current	$I_{11 \text{ V DC}} = 2.5 \text{ mA}$, $I_{30 \text{ V DC}} = 7 \text{ mA}$

Output

Current output	0 ... 20 mA or 4 ... 20 mA
• Signal range	$< 800 \Omega$
• Load	0.1 ... 30 s, adjustable
• Time constant	
Digital output	0 ... 10 kHz, 50 % duty cycle (uni/bidirectional)
• Frequency	24 V DC, 30 mA, $1 \text{ K}\Omega \leq R_i \leq 10 \text{ K}\Omega$, short-circuit-protected (power supplied from flowmeter)
• Pulse (active)	3 ... 30 V DC, max. 110 mA, $200 \Omega \leq R_i \leq 10 \text{ K}\Omega$ (powered from connected equipment)
• Pulse (passive)	0.1 ... 30 s, adjustable
• Time constant	
Relay output	Changeover relay, same as current output
• Time constant	42 V AC/2 A, 24 V DC/1 A
• Load	

Low flow cut off	0 ... 9.9 % of maximum flow
-------------------------	-----------------------------

Galvanic isolation	All inputs and outputs are galvanically isolated.
---------------------------	---

Max. measuring error (incl. sensor and zero point)

• MAG 5000	0.4 % ± 1 mm/s
• MAG 6000	0.2 % ± 1 mm/s

Rated operation conditions

Ambient temperature	
• Operation	<ul style="list-style-type: none"> Display version: -20 ... +60 °C (-4 ... +140 °F) Blind version: -20 ... +60 °C (-4 ... +140 °F) MI-001 version: -25 ... +55 °C (-13 ... +131 °F) Custody Transfer (CT) version: -20 ... +50 °C (-4 ... +122 °F)
• Storage	-40 ... +70 °C (-40 ... +158 °F)

Mechanical load (vibration)

Compact version	18 ... 1000 Hz, 3.17 g rms, sinusoidal in all directions to IEC 68-2-36
19" insert	1 ... 800 Hz, 1 g, sinusoidal in all directions to IEC 68-2-36

Degree of protection

Compact version	IP67/NEMA 4X/6 to IEC 529 and DIN 40050 (1 mH ₂ O 30 min.)
19" insert	IP20/NEMA 1 to IEC 529 and DIN 40050

EMC performance	IEC/EN 61326-1 (all environments) IEC/EN 61326-2-5
------------------------	---

Display and keypad

Totalizer	Two eight-digit counters for forward, net or reverse flow
-----------	---

Display	Background illumination with alphanumeric text, 3 x 20 characters to indicate flow rate, totalized values, settings and faults; Reverse flow indicated by negative sign
----------------	---

Time constant	Time constant as current output time constant
---------------	---

Design

Enclosure material	Fiber glass reinforced polyamide; stainless steel AISI 316/1.4436 (IP65)
• Compact version	
• 19" insert	Standard 19" insert of aluminum/steel (DIN 41494), width: 21 TE, height: 3 HE
• Back of panel	IP20/NEMA 1; Aluminum
• Panel mounting	IP20/NEMA 1 (prepared for IP65/NEMA 2 display side); ABS plastic
• Wall mounting	IP66/NEMA 4X; ABS plastic

Dimensions

Compact version	See dimensional drawings
19" insert	See dimensional drawings

Weight

Compact version	0.75 kg (2 lb)
19" insert	See dimensional drawings

Power supply	<ul style="list-style-type: none"> 115 ... 230 V AC +10 % -15 %, 50 ... 60 Hz 11 ... 30 V DC or 11 ... 24 V AC
---------------------	--

Power consumption	<ul style="list-style-type: none"> 230 V AC: 17 VA 24 V AC: 9 VA, $I_N = 380 \text{ mA}$, $I_{ST} = 8 \text{ A}$ (30 ms) 12 V DC: 11 W, $I_N = 920 \text{ mA}$, $I_{ST} = 4 \text{ A}$ (250 ms) 24 V DC: 8.4 VA, $I_N = 350 \text{ mA}$, $I_{ST} = 4 \text{ A}$ (10 ms) <p>$I_{ST} = 4 \text{ A}$ (250 ms): For solar panel please secure stable current supply</p>
--------------------------	--

Certificates and approvals

Custody transfer approval (MAG 5000/6000 CT)	<p>CE, C-UL general purpose, C-tick; FM Class I, Div 2, CSA Class I, Div 2</p> <ul style="list-style-type: none"> Cold water: MI-001, PTB/OIML R 49 (pattern approval DE/DK) Hot water: PTB and DANAK (MAG 6000 CT) Chilled water: PTB K 7.2; OE12/C 040 Other media than water (milk, beer etc.): PTB and DANAK OIML R 117 (pattern approval DE/DK) (MAG 6000 CT)
--	--

Communication

Standard	Without serial communication or HART as option
• MAG 5000	Prepared for client-mounted add-on modules
• MAG 6000	HART, Modbus RTU/RS 485, FOUNDATION Fieldbus H1, DeviceNet, PROFIBUS PA, PROFIBUS DP as add-on modules
Optional (MAG 6000 only)	No communication modules approved
• MAG 5000/6000 CT	

Safety barrier (e/ia)

Application	For use with MAG 5000/6000 19" and MAG 1100 Ex ATEX/MAG 3100 Ex ATEX		
Ex approval	MAG 1100 Ex [EEx e ia] IIB ATEX MAG 3100 Ex [EEx e ia] IIC ATEX		
Cable parameter	Group	Capacity in μF	Inductance in mH
Electrode	IIC	≤ 4.1	≤ 80
	IIB	≤ 45	≤ 87
	IIA	≤ 45	≤ 87
Ambient temperature			
• During operation	-20 ... +50 °C (-4 ... +122 °F)		
• During storage	-20 ... +70 °C (-4 ... +158 °F)		
Enclosure			
• Material	Standard 19" insert in aluminum/steel (DIN 41494)		
• Width	21 TE (4.75")		
• Height	3 HE (5.25")		
• Rating	IP20 / NEMA 1 to EN 60529		
• Mechanical load	1 g, 1 ... 800 Hz sinusoidal in all directions to EN 60068-2-36		





Flow Measurement

SITRANS F M

Transmitter MAG 5000/6000







Selection and Ordering data

Transmitter MAG 5000





Description	Article No.	
Transmitter MAG 5000 Blind for compact and wall mounting; IP67/NEMA 4X/6, fibre glass reinforced polyamide <ul style="list-style-type: none"> • 11 ... 30 V DC/ 11 ... 24 V AC • 115 ... 230 V AC, 50/60 Hz 	<ul style="list-style-type: none"> • 7ME6910-1AA30-0AA0 • 7ME6910-1AA10-0AA0 	
Transmitter MAG 5000 Display for compact and wall mounting; IP67/NEMA 4X/6, fibre glass reinforced polyamide <ul style="list-style-type: none"> • 11 ... 30 V DC/ 11 ... 24 V AC • 115 ... 230 V AC, 50/60 Hz • 115 ... 230 V AC, 50/60 Hz, with HART 	<ul style="list-style-type: none"> • 7ME6910-1AA30-1AA0 • 7ME6910-1AA10-1AA0 • 7ME6910-1AA10-1BA0 	
Transmitter MAG 5000 CT for compact and wall mounting, approved for custody transfer (only with approval marks, no verification – only a complete flowmeter can be verified, i.e. sensor together with the transmitter); IP67/NEMA 4X/6, fibre glass reinforced polyamide <ul style="list-style-type: none"> • 11 ... 30 V DC/ 11 ... 24 V AC • 115 ... 230 V AC, 50/60 Hz 	<ul style="list-style-type: none"> • 7ME6910-1AA30-1AB0 • 7ME6910-1AA10-1AB0 	
Transmitter MAG 5000 for 19" rack and wall mounting <ul style="list-style-type: none"> • 11 ... 30 V DC/ 11 ... 24 V AC • 115 ... 230 V AC, 50/60 Hz 	<ul style="list-style-type: none"> • 7ME6910-2CA30-1AA0 • 7ME6910-2CA10-1AA0 	

◆ We can offer shorter delivery times for configurations designated with the Quick Ship Symbol ◆. For details see page 9/5 in the appendix.

Transmitter MAG 6000

Description	Article No.	
Transmitter MAG 6000 Blind for compact and wall mounting; IP67/NEMA 4X/6, fibre glass reinforced polyamide <ul style="list-style-type: none"> • 11 ... 30 V DC/ 11 ... 24 V AC • 115 ... 230 V AC, 50/60 Hz 	<ul style="list-style-type: none"> • 7ME6920-1AA30-0AA0 • 7ME6920-1AA10-0AA0 	
Transmitter MAG 6000 for compact and wall mounting; IP67/NEMA 4X/6, fibre glass reinforced polyamide <ul style="list-style-type: none"> • 11 ... 30 V DC/ 11 ... 24 V AC • 115 ... 230 V AC, 50/60 Hz 	<ul style="list-style-type: none"> • 7ME6920-1AA30-1AA0 • 7ME6920-1AA10-1AA0 	
Transmitter MAG 6000 for compact and wall mounting; IP65/NEMA 4, stainless steel AISI 316/1.4436 (only for sensor with SS terminal box) (for remote installation order SS terminal box separately) <ul style="list-style-type: none"> • 11 ... 30 V DC/ 11 ... 24 V AC • 115 ... 230 V AC, 50/60 Hz 	<ul style="list-style-type: none"> • 7ME6920-1QA30-1AA0 • 7ME6920-1QA10-1AA0 	
Transmitter MAG 6000 CT for compact and wall mounting, approved for custody transfer (no communication modules possible; only with approval marks, no verification – only a complete flowmeter can be verified, i.e. sensor together with the transmitter); IP67/NEMA 4X/6, fibre glass reinforced polyamide <ul style="list-style-type: none"> • 11 ... 30 V DC/ 11 ... 24 V AC • 115 ... 230 V AC, 50/60 Hz 	<ul style="list-style-type: none"> • 7ME6920-1AA30-1AB0 • 7ME6920-1AA10-1AB0 	
Transmitter MAG 6000 SV for compact and wall mounting; special excitation 44 Hz settings for Batch application DN ≤ 25/1" IP67/NEMA 4X/6, fibre glass reinforced polyamide <ul style="list-style-type: none"> • 11 ... 30 V DC/ 11 ... 24 V AC • 115 ... 230 V AC, 50/60 Hz 	<ul style="list-style-type: none"> • 7ME6920-1AB30-1AA0 • 7ME6920-1AB10-1AA0 	
Transmitter MAG 6000 for 19" rack and wall mounting <ul style="list-style-type: none"> • 11 ... 30 V DC/ 11 ... 24 V AC • 115 ... 230 V AC, 50/60 Hz 	<ul style="list-style-type: none"> • 7ME6920-2CA30-1AA0 • 7ME6920-2CA10-1AA0 	

Transmitter MAG 5000/6000

Description	Article No.	
Transmitter MAG 6000 SV for 19" rack and wall mounting; special excitation 44 Hz settings for Batch application DN ≤ 25/1"		
<ul style="list-style-type: none"> • 11 ... 30 V DC/ 11 ... 24 V AC • 115 ... 230 V AC, 50/60 Hz 	7ME6920-2CB30-1AA0 7ME6920-2CB10-1AA0	
MAG 6000 with IP66/NEMA 4X enclosure; 115 ... 230 V AC, 50/60 Hz; cable gland PG13.5	7ME6920-2EA10-1AA0	
MAG 6000 with safety barrier for Ex-approved sensors, complete mounted with IP66/NEMA 4X wall mounting enclosure, ATEX, 115 ... 230 V AC, 50/60 Hz; cable gland PG13.5	7ME6920-2MA11-1AA0	
<ul style="list-style-type: none"> • For ATEX 2G D sensors 		
MAG 6000 SV, 19" insert, in IP66/NEMA 4X, ABS plastic enclosure, excitation frequency 44 Hz for Batch application DN ≤ 25/1"; cable gland PG13.5		
<ul style="list-style-type: none"> • 11 ... 30 V DC, 11 ... 24 V AC, 50/60 Hz • 115 ... 230 V AC, 50/60 Hz 	7ME6920-2EB30-1AA0 7ME6920-2EB10-1AA0	

- ◆ We can offer shorter delivery times for configurations designated with the Quick Ship Symbol ◆. For details see page 9/5 in the appendix.

Operating instructions for SITRANS F M MAG 5000/6000

Description	Article No.
For SITRANS F M MAG 5000/6000 IP67	
<ul style="list-style-type: none"> • English • German • Spanish • French 	A5E02338368 A5E02944982 A5E02944995 A5E02944990
For SITRANS F M MAG 5000/6000 19"	
<ul style="list-style-type: none"> • English 	A5E02082880

This device is shipped with a Quick Start guide and a CD containing further SITRANS F literature.

All literature is also available for free at:
<http://www.siemens.com/flowdocumentation>

Communication modules for MAG 6000



Description	Article No.	
HART (not for MAG 6000 I)	◆ FDK:085U0226	
Modbus RTU/RS 485	◆ FDK:085U0234	
PROFIBUS PA Profile 3	◆ FDK:085U0236	
PROFIBUS DP Profile 3	◆ FDK:085U0237	
DeviceNet	◆ FDK:085U0229	
FOUNDATION Fieldbus H1	A5E02054250	

Operating instructions for SITRANS F add-on modules

Description	Article No.
HART	
<ul style="list-style-type: none"> • English 	A5E03089708
PROFIBUS PA/DP	
<ul style="list-style-type: none"> • English • German 	A5E00726137 A5E01026429
MODBUS	
<ul style="list-style-type: none"> • English • German • Spanish • French 	A5E00753974 A5E03089262 A5E03089278 A5E03089265
FOUNDATION Fieldbus	
<ul style="list-style-type: none"> • English • German • Spanish • French 	A5E02318728 A5E02488856 A5E02512177 A5E02512169
DeviceNet	
<ul style="list-style-type: none"> • English 	A5E03089720

This device is shipped with a Quick Start guide and a CD containing further SITRANS F literature.

Accessories for MAG 5000 and MAG 6000





Description	Article No.	
Wall mounting unit for IP67/ NEMA 4X/6 version, wall bracket, terminal box in polyamide		
<ul style="list-style-type: none"> • 4 x M20 cable glands • 4 x 1/2" NPT cable glands 	FDK:085U1018 FDK:085U1053	
Sun lid for MAG 5000/6000 transmitter (Frame and lid)	A5E02328485	
Cable for standard electrode or coil, 3 x 1.5 mm ² / 18 gage with shield PVC; Temperature range: -30 ... +70 °C (-22 ... +158 °F)		
<ul style="list-style-type: none"> • 10 m (33 ft) • 20 m (65 ft) • 40 m (130 ft) • 60 m (200 ft) • 100 m (330 ft) • 150 m (500 ft) • 200 m (650 ft) • 500 m (1650 ft) 	FDK:083F0121 FDK:083F0210 FDK:083F0211 FDK:083F0212 FDK:083F0213 FDK:083F3052 FDK:083F3053 FDK:083F3054	





- ◆ We can offer shorter delivery times for configurations designated with the Quick Ship Symbol ◆. For details see page 9/5 in the appendix.

Flow Measurement

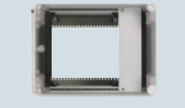
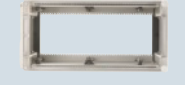
SITRANS F M

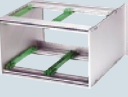
Transmitter MAG 5000/6000







Description	Article No.	
<p>Electrode cable for empty pipe or low conductivity¹⁾, double shielded, 3 x 0.25 mm². Temperature range : -30 ... +70 °C (-22 ... +158 °F)</p> <ul style="list-style-type: none"> • 10 m (33 ft) ◆ FDK:083F3020 • 20 m (65 ft) ◆ FDK:083F3095 • 40 m (130 ft) FDK:083F3094 • 60 m (200 ft) FDK:083F3093 • 100 m (330 ft) FDK:083F3092 • 150 m (500 ft) FDK:083F3056 • 200 m (650 ft) FDK:083F3057 • 500 m (1650 ft) FDK:083F3058 		
<p>Low-noise electrode coax cable for low conductivity and high vibration levels of cables, 3 x 0.13 mm²</p> <ul style="list-style-type: none"> • 2 m (6.6 ft) A5E02272692 • 5 m (16.5 ft) A5E02272723 • 10 m (33 ft) A5E02272730 		
<p>Cable kit with standard coil cable¹⁾, 3 x 1.5 mm²/18 gage with shield PVC and electrode cable double shielded, 3 x 0.25 mm² Temperature range: -30 ... +70 °C (-22 ... +158 °F)</p> <ul style="list-style-type: none"> • 5 m (16.5 ft) ◆ A5E02296329 • 10 m (33 ft) ◆ A5E01181647 • 15 m (49 ft) ◆ A5E02296464 • 20 m (65 ft) ◆ A5E01181656 • 25 m (82 ft) ◆ A5E02296490 • 30 m (98 ft) ◆ A5E02296494 • 40 m (130 ft) ◆ A5E01181686 • 50 m (164 ft) ◆ A5E02296498 • 60 m (200 ft) A5E01181689 • 100 m (330 ft) A5E01181691 • 150 m (500 ft) A5E01181699 • 200 m (650 ft) A5E01181703 • 500 m (1650 ft) A5E01181705 		
<p>Potting kit for terminal box of flow sensors for IP68/NEMA 6P (not for Ex sensors)</p>	◆ FDK:085U0220	
<p>19" safety barrier (21 TE) [EEx e ia] IIC for MAG 1100 Ex sensors and MAG 3100 Ex sensors, incl. back plate</p>	FDK:083F5034	
<p>Panel mounting enclosure for 19" insert (21 TE); IP65/NEMA 2 enclosure in ABS plastic for front panel mounting</p>	FDK:083F5030	
<p>Panel mounting enclosure for 19" insert (42 TE); IP65/NEMA 2 enclosure in ABS plastic for front panel mounting</p>	FDK:083F5031	



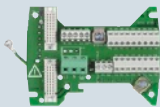

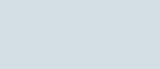
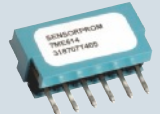



Description	Article No.	
<p>Back of panel mounting enclosure for 19" insert (21 TE); IP20/NEMA 1 enclosure in aluminum</p>	FDK:083F5032	
<p>Back of panel mounting enclosure for 19" insert (42 TE); IP20/NEMA 1 enclosure in aluminum</p>	FDK:083F5033	
<p>IP66/NEMA 4X, wall mounting enclosure for 19" inserts (without back plates). Use with PCB A5E02559813 or A5E02559814</p> <ul style="list-style-type: none"> • 21 TE FDK:083F5037 • 42 TE FDK:083F5038 		
<p>Front cover (7TE) for panel mounting enclosure</p>	FDK:083F4525	
<p>Sun shield for remote MAG 5000/6000 transmitters</p>	A5E01209496	
<p>Sun Shield for compact MAG 5000/6000 transmitters on MAG 3100 (DN 15 ... 2000 (1/2" ... 78") or MAG 5100 W (DN 150 ... 1200 (6" ... 48"))</p>	A5E01209500	

◆ We can offer shorter delivery times for configurations designated with the Quick Ship Symbol ◆. For details see page 9/5 in the appendix.

1) Not for MAG 6000 with safety barrier

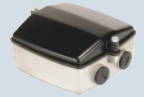
Spare parts

Description	Article No.	
Connection board (for polyamide terminalbox) <ul style="list-style-type: none"> • 12 ... 24 V • 115 ... 230 V 	A5E02559817 A5E02559816	
Connection board (for stainless steel terminal- box) <ul style="list-style-type: none"> • 12 ... 24 V • 115 ... 230 V 	A5E02604280 A5E02604272	
19" enclosure, 12 ... 24 V, 115 ... 230 V <ul style="list-style-type: none"> • Connection board for stan- dard 19" transmitter 	A5E02559809	
<ul style="list-style-type: none"> • Connection board for transmitter ia and safety barrier 	A5E02559810	
<ul style="list-style-type: none"> • Connection board for transmitter ia/ib and safety barrier (only for sensors produced before October 2007) 	A5E02559811	
<ul style="list-style-type: none"> • Connection board for transmitter and cleaning unit 	FDK:083F4123	
SENSORPROM memory unit (Sensor code and serial numbers must be specified on order) <ul style="list-style-type: none"> • 2 kB (for MAG 5000/6000/ MAG 6000 I) - 1 pc. - 10 pcs. 	FDK:085U1005 FDK:083F5052 FDK:085U1008	
Display unit for MAG 5000/6000 <ul style="list-style-type: none"> • Black neutral front 	FDK:085U1038	
<ul style="list-style-type: none"> • Siemens front 	FDK:085U1039	
Display unit for 19" versions	FDK:085U3349	

Description	Article No.	
Cable glands, for above cable, 4 pcs. <ul style="list-style-type: none"> • M20 • ½" NPT • PG 13.5, 2 pcs. 	A5E00822490 A5E00822501 FDK:083G0228	 ½" NPT M20
Sealing screws for sensor/ transmitter, 2 pcs	FDK:085U0221	
Terminal box, in polyamide, inclusive lid <ul style="list-style-type: none"> • M20 • ½" NPT 	FDK:085U1050 FDK:085U1052	
Terminal box lid, in polyam- ide	FDK:085U1003	
Terminal box, in stainless steel, inclusive lid for MAG 6000 in stainless steel and for all Ex sensors <ul style="list-style-type: none"> • M20 • ½" NPT 	A5E00836867 A5E00836868	
Terminal box (3A) for MAG 1100 F in polyamide, inclusive lid <ul style="list-style-type: none"> • M20 • ½" NPT 	A5E00822478 A5E00822479	
Wall unit enclosure IP66, 12 ... 24 V, 115 ... 230 V <ul style="list-style-type: none"> • PCB for standard transmitter 	A5E02559813	
<ul style="list-style-type: none"> • PCB for transmitter ia/e and safety barrier 	A5E02559814	
<ul style="list-style-type: none"> • PCB for transmitter ia/ib and safety barrier (7ME6130, 7ME6150 and 7ME6330) 	A5E02559812	
<ul style="list-style-type: none"> • PCB for transmitter and cleaning unit 	A5E02559815	

◆ We can offer shorter delivery times for configurations designated with the Quick Ship Symbol ◆. For details see page 9/5 in the appendix.

Flow Measurement SITRANS F M

Transmitter MAG 5000/6000

Dimensional drawings

Transmitter IP67/NEMA 4X/6 compact polyamide

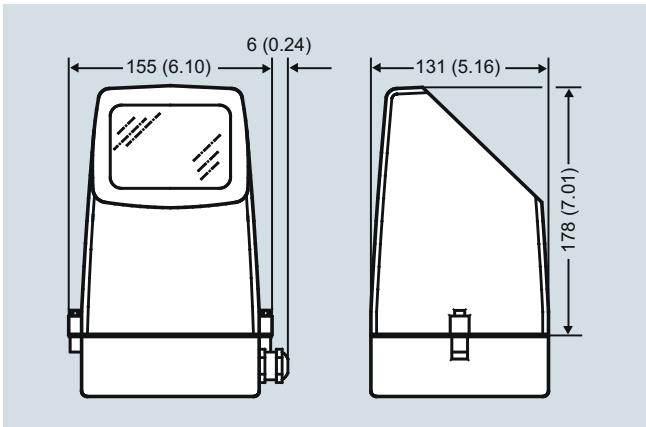

Transmitter compact mounted, dimensions in mm (inch)

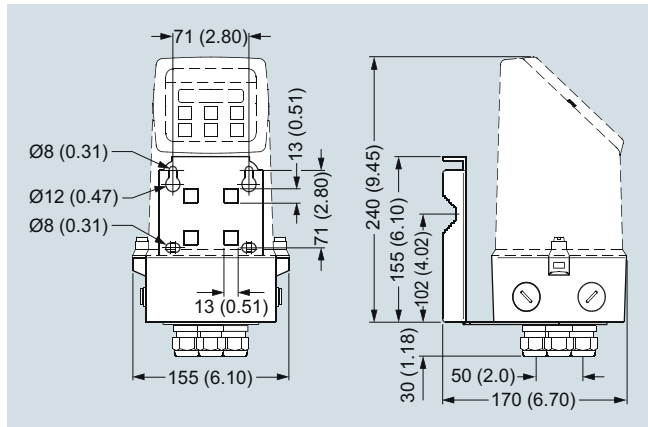

Transmitter wall mounted, dimensions in mm (inch)

Transmitter, 19" IP20/NEMA 1 standard unit

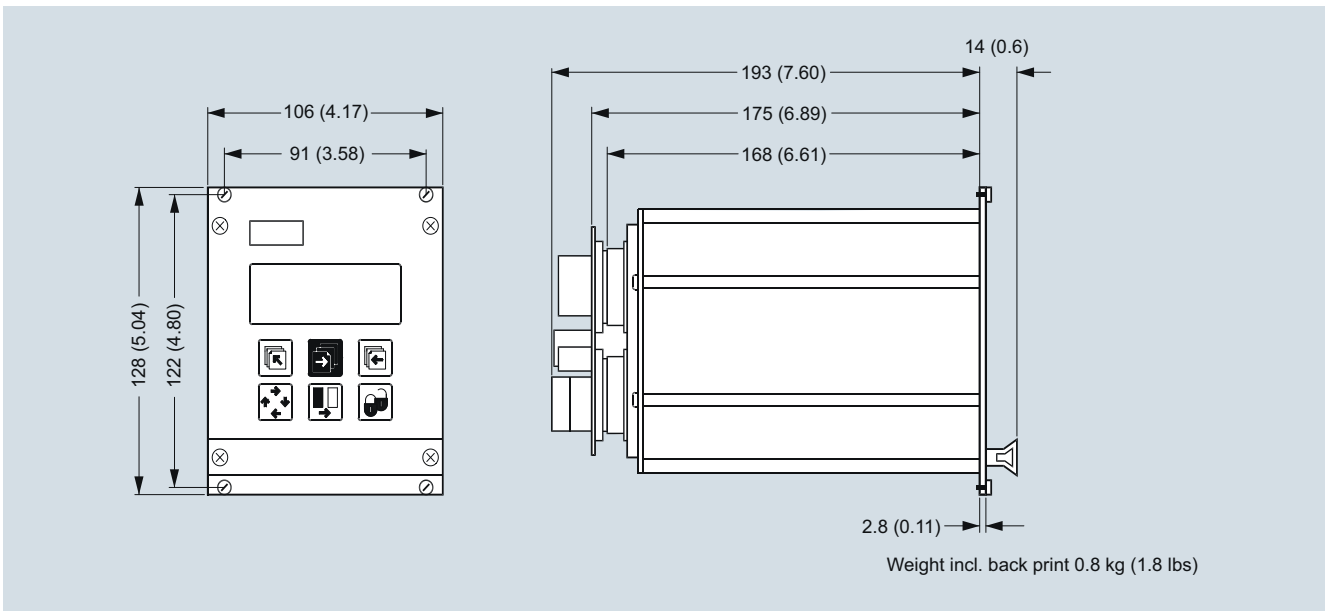

Dimensions in mm (inch)

3

Transmitter MAG 5000/6000

Transmitter, wall mounting IP66/NEMA 4X, 21 TE

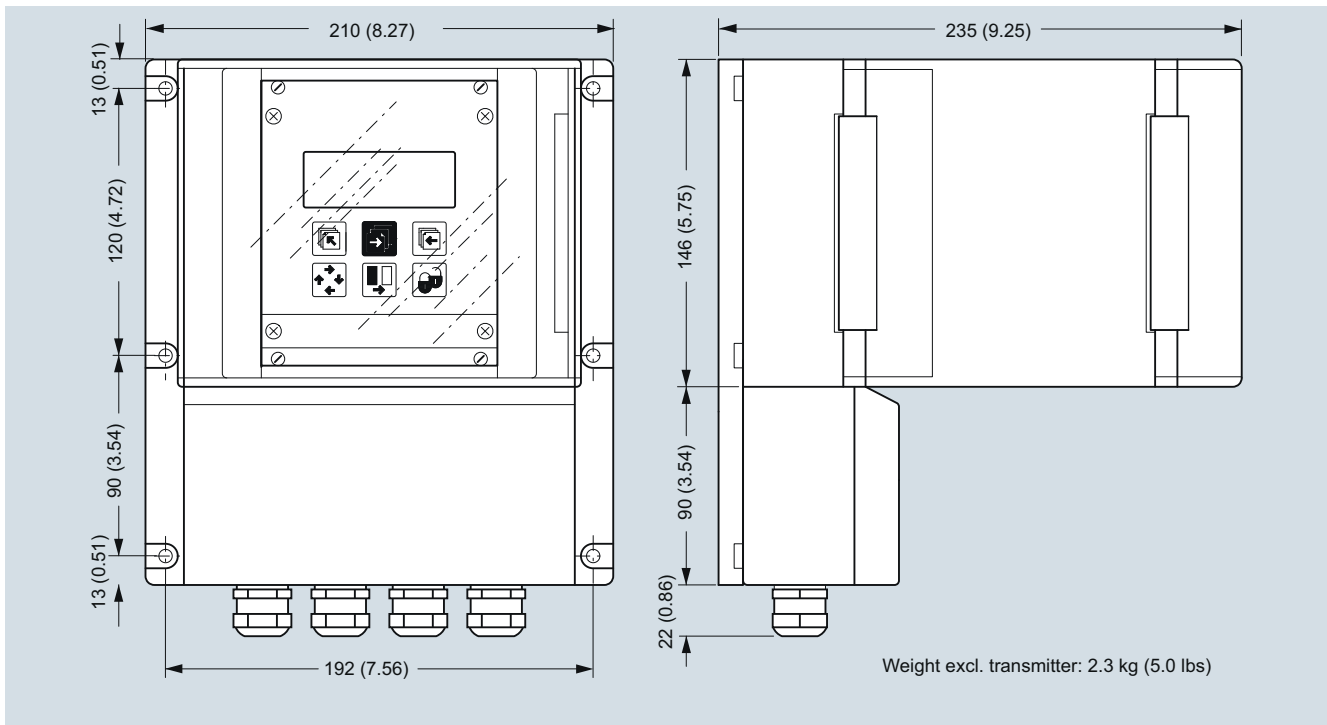

Dimensions in mm (inch)

Transmitter, wall mounting IP66/NEMA 4X, 42 TE

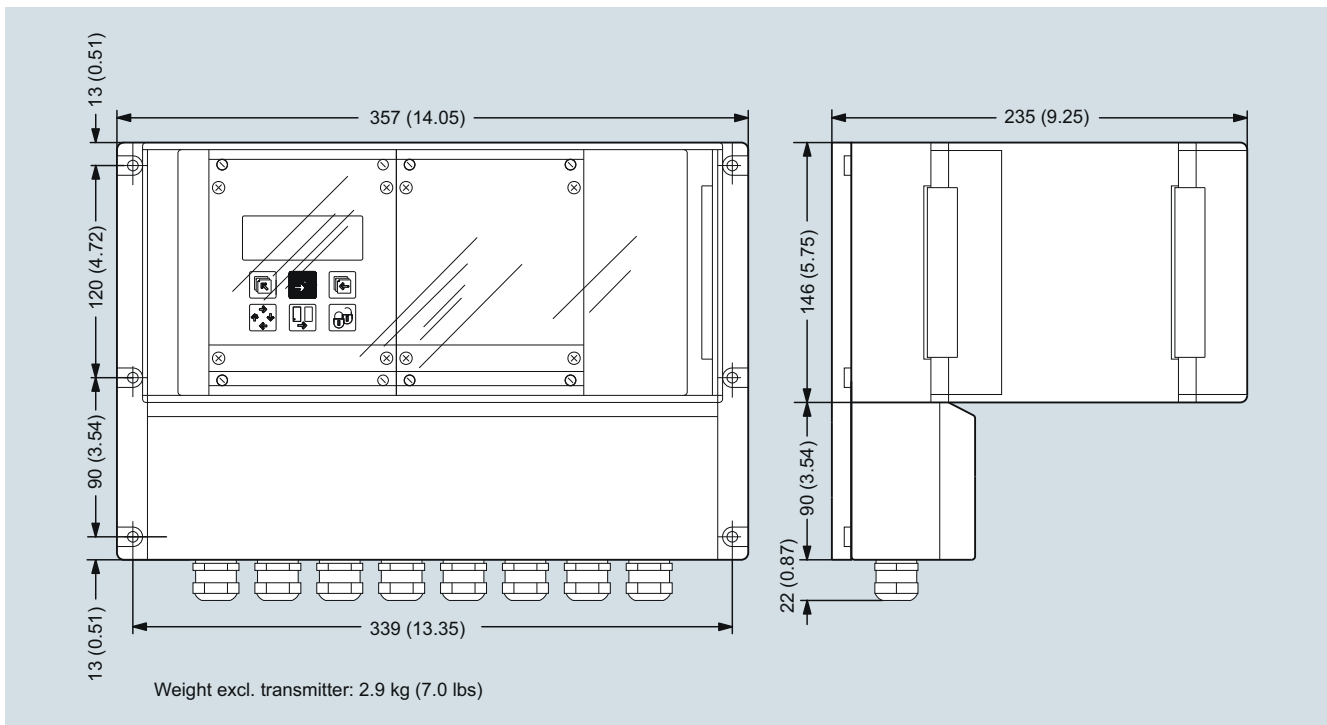

Dimensions in mm (inch)

Flow Measurement

SITRANS F M

Transmitter MAG 5000/6000

Transmitter, panel front IP20/NEMA 1, 21 TE

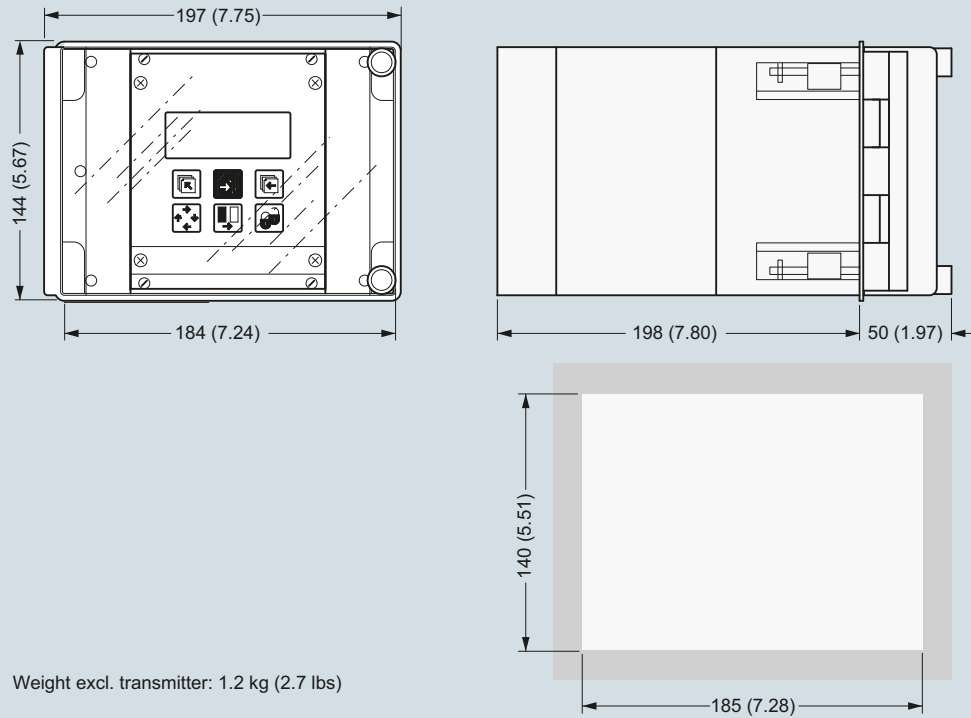

Dimensions in mm (inch)

Transmitter, panel front IP20/NEMA 1, 42 TE

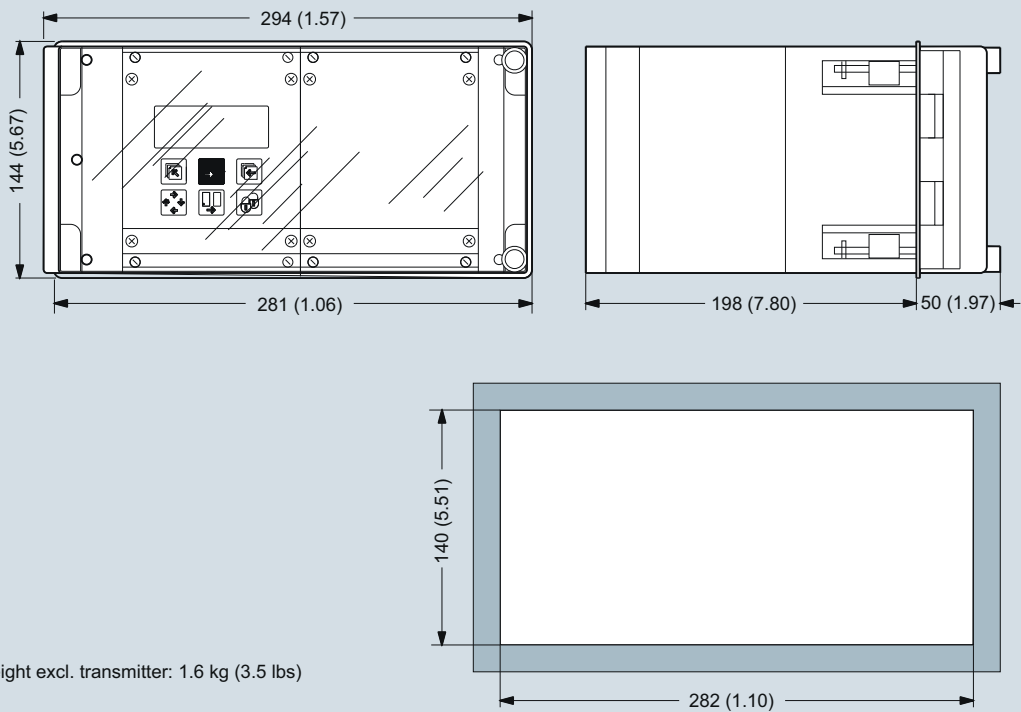

Dimensions in mm (inch)

Transmitter, back of panel IP20/NEMA 1, 21 TE

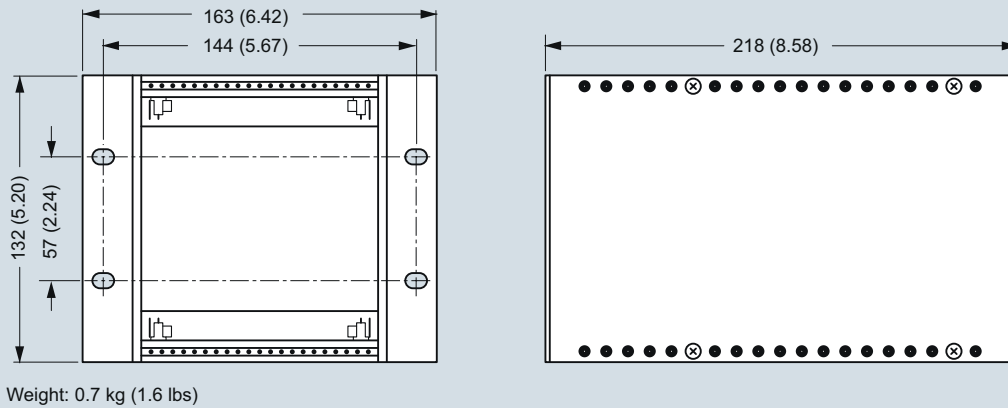

Dimensions in mm (inch)

Transmitter, back of panel IP20/NEMA 1, 42 TE

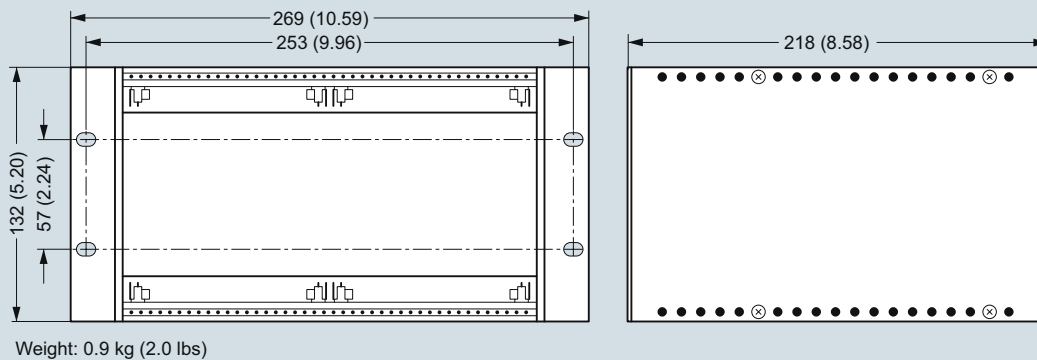

Dimensions in mm (inch)

Flow Measurement SITRANS F M

Transmitter MAG 5000/6000

Schematics

Electrical connection

Grounding

PE must be connected due to safety class 1 power supply.

Mechanical counters

When mounting a mechanical counter to terminals 57 and 58 (active output), a 1000 μ F capacitor must be connected to the terminals 56 and 58. Capacitor + is connected to terminal 56 and capacitor - to terminal 58.

Output cables

If the output cable length is long in noisy environment, we recommend to use shielded cable.

3

